

Date: _____

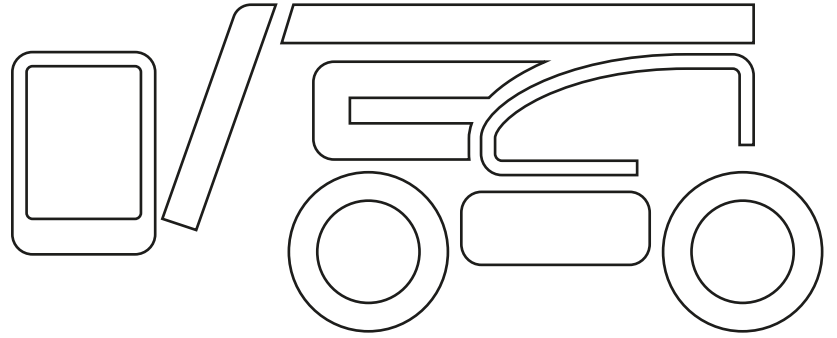

Colour me
nifty
Activity Book

Name: _____

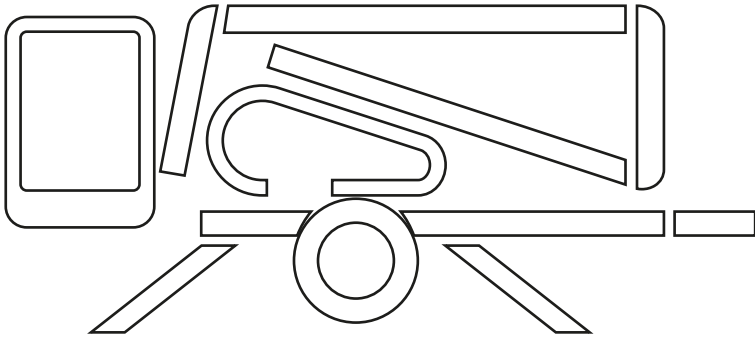
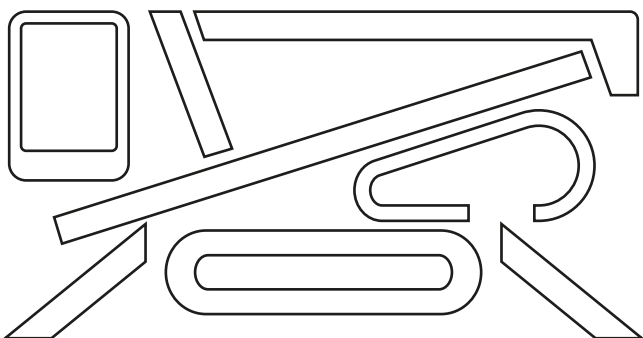
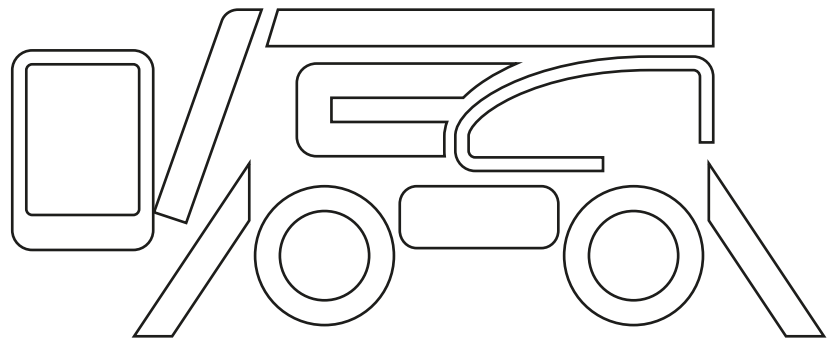

niftylift

Word Search

F	B	W	V	X	K	B	O	L	M	Z	U	V	V	U	F	R	M	S	J
X	W	E	X	D	Z	A	B	N	S	K	H	X	O	G	W	F	C	B	O
A	F	Q	S	I	N	C	A	G	E	R	O	T	A	T	I	O	N	X	C
D	P	B	M	F	X	M	Q	T	L	I	W	Y	S	X	J	Z	E	S	B
A	F	B	G	O	Z	O	F	N	F	D	Q	X	R	E	G	D	V	C	W
J	G	W	X	L	L	I	Y	E	P	B	A	C	Q	N	J	D	I	I	J
R	R	F	P	S	L	D	M	I	R	R	O	E	B	X	V	I	T	T	F
I	J	E	A	Y	P	M	A	C	O	M	O	P	B	D	A	D	A	A	Y
L	F	A	T	H	G	M	A	I	P	Y	R	L	S	X	O	I	V	M	T
K	N	F	D	T	U	R	T	F	E	G	S	I	I	O	W	Q	O	E	F
R	I	Z	Q	Z	L	O	N	F	L	P	I	S	H	V	X	O	N	L	B
N	F	J	R	T	H	F	S	E	L	X	O	R	Y	T	D	C	N	E	Y
J	G	K	S	D	X	T	M	K	E	P	P	U	B	H	S	O	I	T	F
V	T	L	B	T	A	A	O	Q	D	O	S	R	R	A	O	U	K	O	L
P	A	W	M	Z	Y	L	L	N	W	R	Q	F	I	L	D	T	X	P	Y
Y	L	D	L	R	K	P	C	Z	X	O	G	V	D	L	Y	R	W	S	B
O	M	K	R	R	O	T	R	A	M	S	Z	D	N	E	W	I	O	P	O
H	L	R	I	T	V	F	E	C	F	Y	W	K	Q	L	E	G	R	K	O
G	E	D	H	P	R	M	T	P	D	A	T	Z	K	E	H	G	K	Y	M
O	D	I	T	C	C	V	S	A	T	U	B	I	D	C	T	E	I	L	A
X	B	I	G	Y	H	Z	L	R	L	N	S	N	V	T	K	R	N	A	H
Q	P	U	L	H	X	D	A	R	B	P	U	C	I	R	N	J	G	S	L
C	Z	M	Y	A	T	C	O	I	F	Z	S	K	A	I	D	I	H	N	A
L	F	G	S	U	K	R	E	K	E	L	O	S	S	C	W	I	E	I	C
Y	Z	K	Y	D	G	N	I	Z	L	T	B	W	E	K	L	C	I	R	F
U	H	O	R	Q	E	R	J	D	X	C	V	O	H	C	H	Q	G	L	T
C	R	I	F	R	C	A	K	Q	E	E	B	N	P	R	C	E	H	J	H
J	V	I	G	M	G	T	K	H	R	R	R	T	B	X	O	A	T	J	Y
E	S	Y	U	I	H	U	S	H	Y	D	R	A	U	L	I	C	R	A	M
F	Z	E	L	I	B	O	M	Q	U	D	C	N	C	B	R	T	S	O	F

accessplatform
allelectric
bienergy
cagerotation
efficient

flyboom
heightrider
hybrid
hydraulicram
innovative

mobile
niftylift
outrigger
platform
selfpropelled

siops
smart
telematics
trackdrive
workingheight

NHS
HEROES

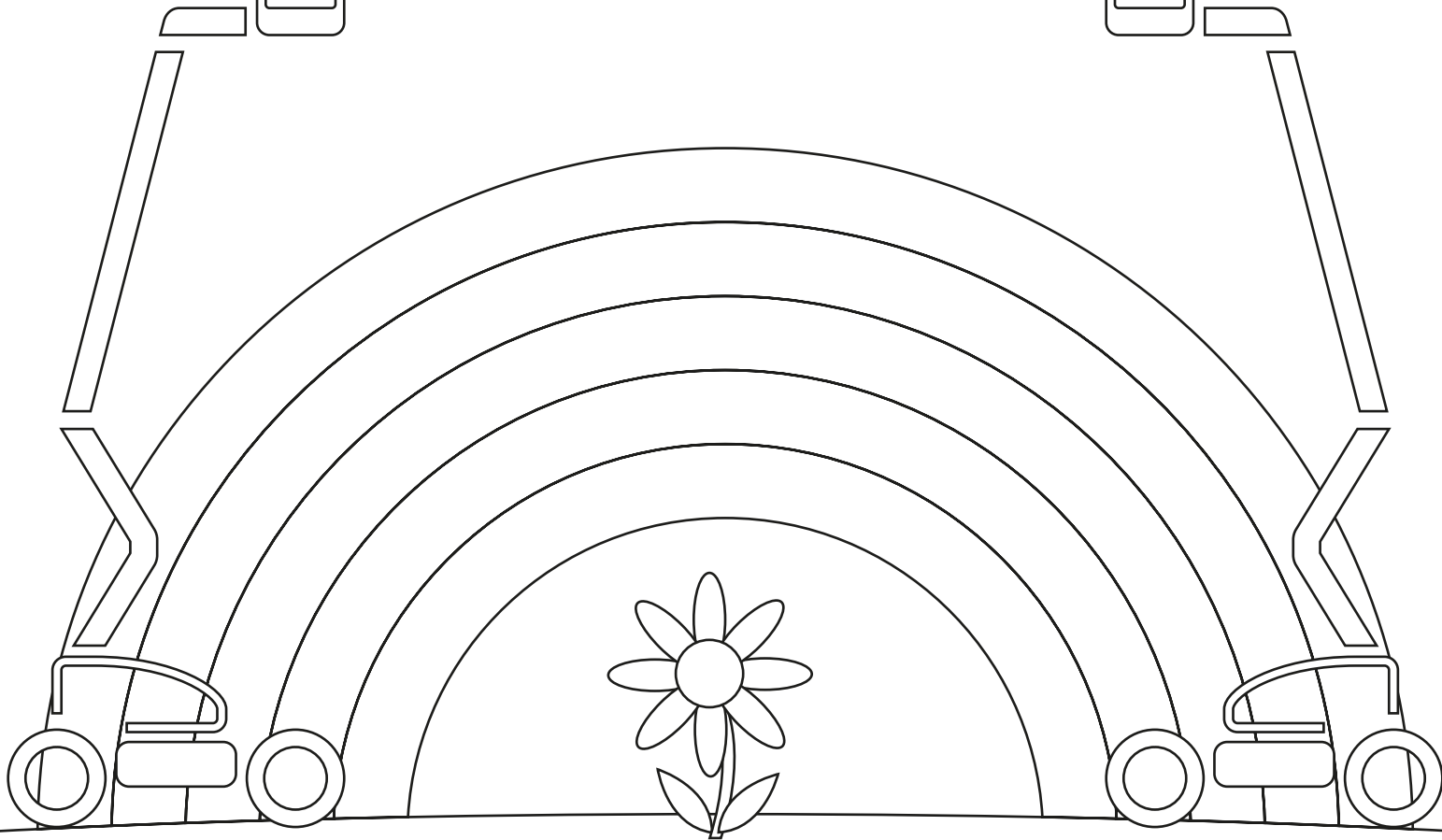
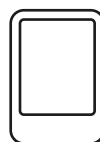
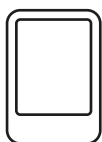

THANK YOU!

HAPPY EASTER

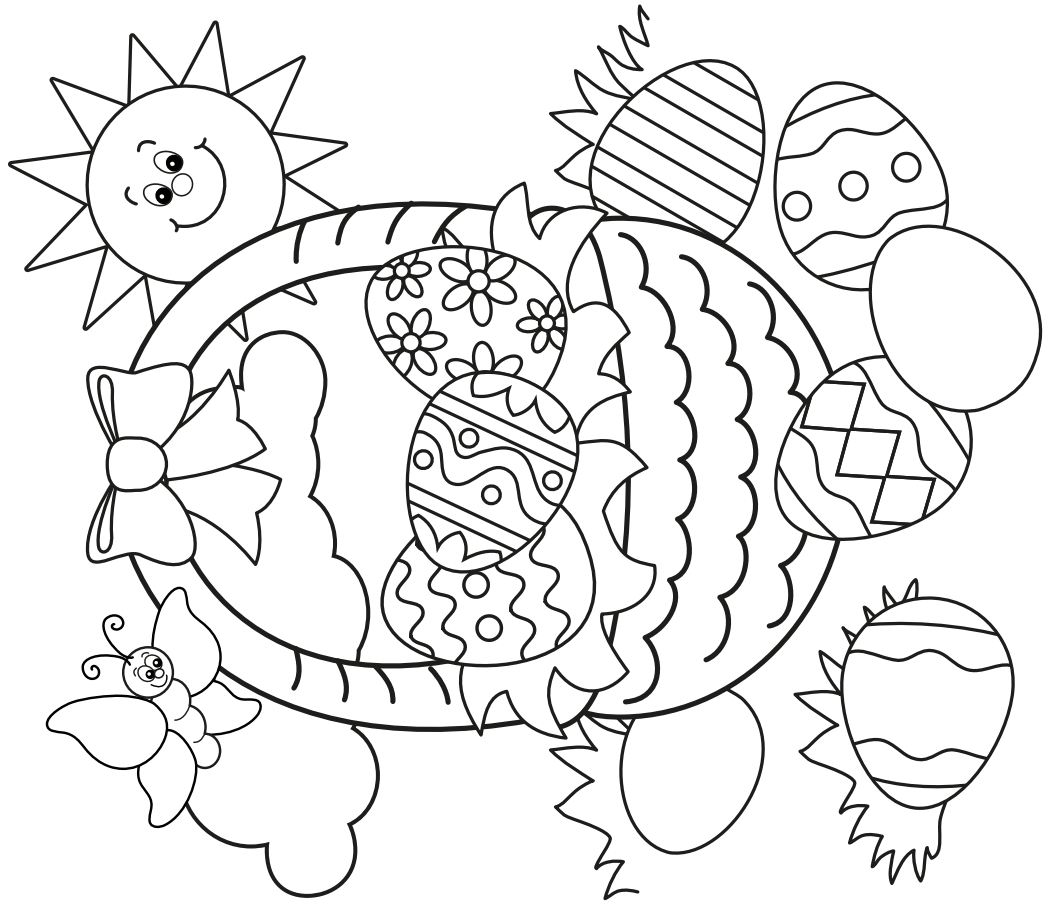

OUTSIDE BACK OF CARD - FOLD HERE

WE HOPE YOU ENJOY COLOURING THIS CARD

PLEASE PRINT 2-SIDED ALONG THE 'LONG-EDGE'

HAPPY EASTER FROM ALL AT NIFTYLIFT!

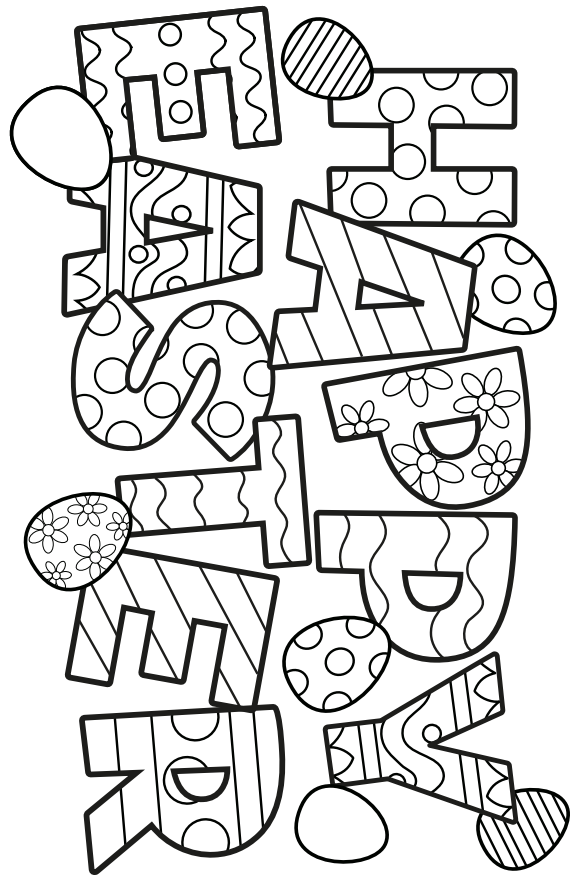

Maze

START

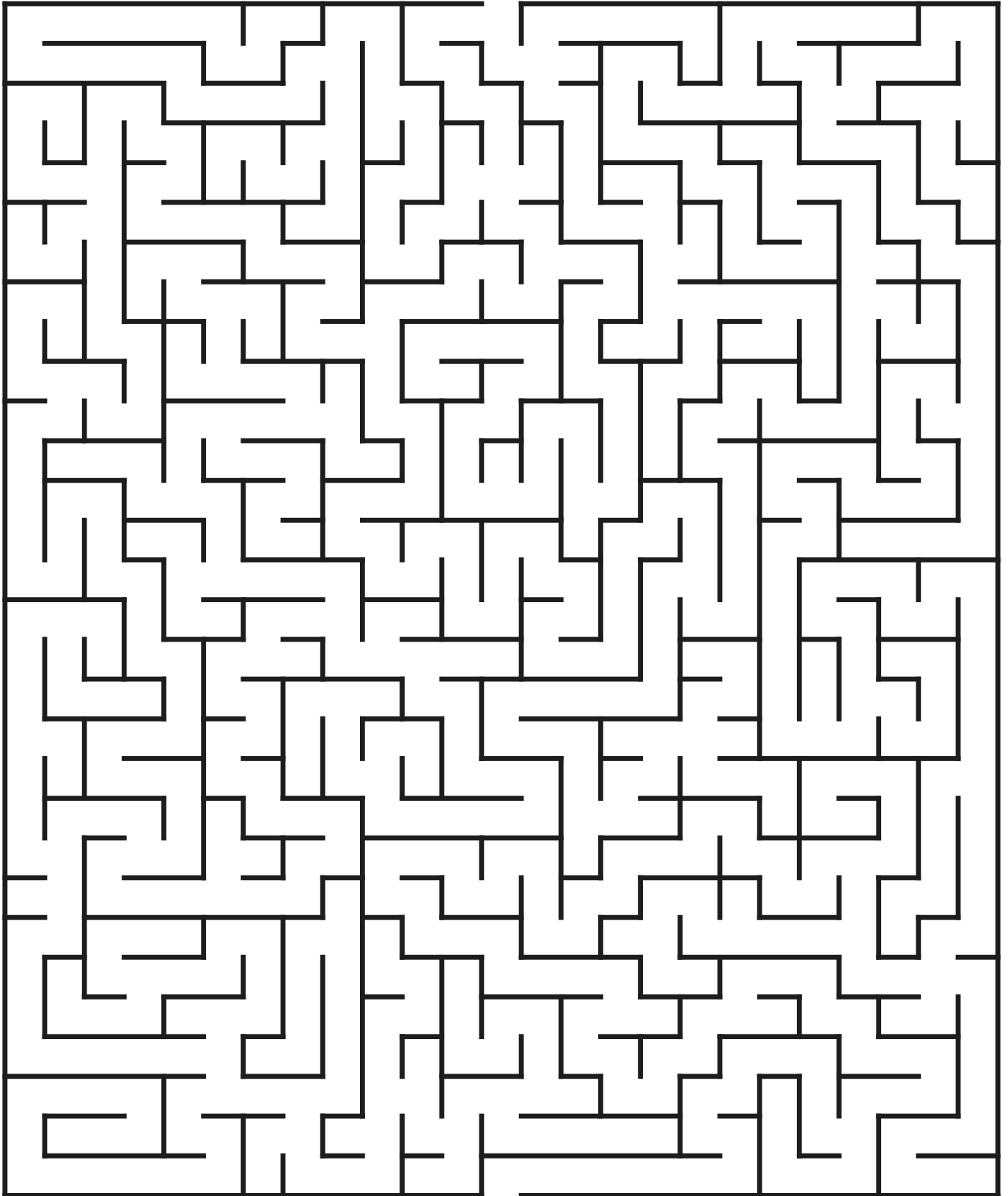

FINISH

Spot the Diff



Can you find all 10?



Sudoku

Easy

1			9				2	
	5	4		3	6		9	
	9			4				
3					2		7	
5		7				2		8
	2		8					4
				2			1	
	7		1	6		8	3	
	6				3			9

Medium

7	3	5		2			6	
					4	8	3	5
							7	
		9	8	3	7		5	
	7		6	5	1	3		
	5							
8	1	7	4					
	2			1		6	8	9

Hard

	8	5		6	4			
	1		7					3
	2		3					
8		3	6					5
5		1				8		9
2					8	3		4
					7		4	
9					3		5	
			2	9		1	3	

Evil

			7	5		9		
	5	9	4				3	
7	6		1					2
		2	9					5
	1						4	
9					1	3		
4					2		6	1
	2				4	8	9	
		1		9	5			

Answers

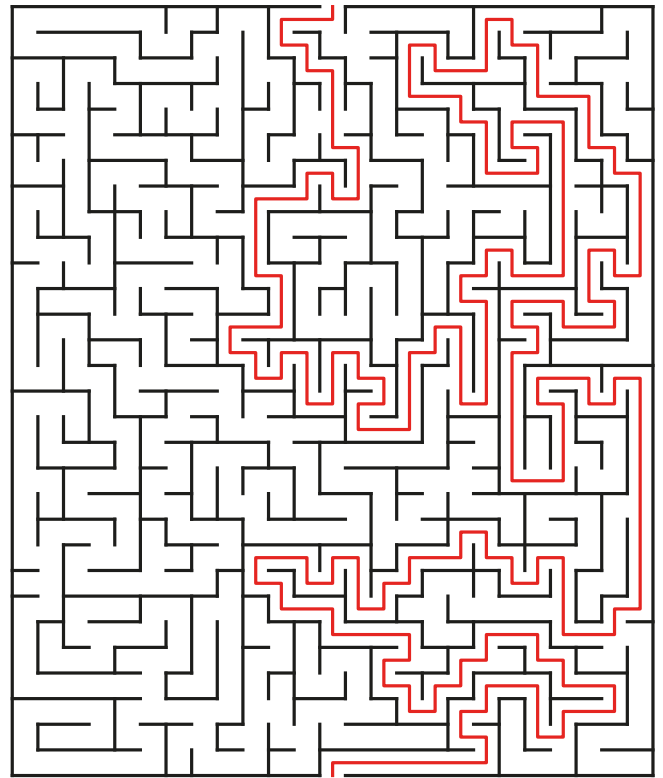
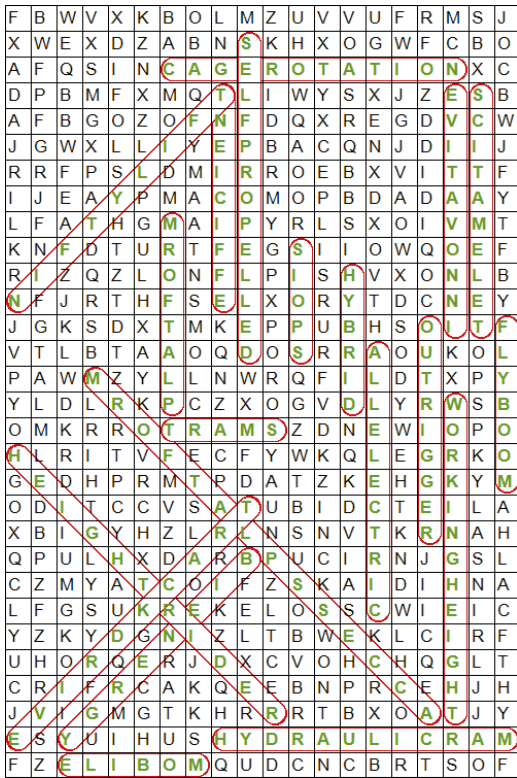

Easy

Medium

Hard

1	3	6	9	7	8	4	2	5
8	5	4	2	3	6	1	9	7
7	9	2	5	4	1	6	8	3
3	4	8	6	5	2	9	7	1
5	1	7	3	9	4	2	6	8
6	2	9	8	1	7	3	5	4
9	8	3	4	2	5	7	1	6
4	7	5	1	6	9	8	3	2
2	6	1	7	8	3	5	4	9

7	3	5	9	2	8	4	6	1
6	9	2	1	7	4	8	3	5
4	8	1	5	6	3	9	7	2
1	4	9	8	3	7	2	5	6
5	6	3	2	4	9	7	1	8
2	7	8	6	5	1	3	9	4
9	5	6	3	8	2	1	4	7
8	1	7	4	9	6	5	2	3
3	2	4	7	1	5	6	8	9

3	8	5	9	6	4	7	2	1
6	1	9	7	2	5	4	8	3
7	2	4	3	8	1	5	9	6
8	4	3	6	7	9	2	1	5
5	6	1	4	3	2	8	7	9
2	9	7	5	1	8	3	6	4
1	3	6	8	5	7	9	4	2
9	7	2	1	4	3	6	5	8
4	5	8	2	9	6	1	3	7

Evil

2	3	4	7	5	6	9	1	8
1	5	9	4	2	8	6	3	7
7	6	8	1	3	9	4	5	2
8	4	2	9	6	3	1	7	5
3	1	6	5	8	7	2	4	9
9	7	5	2	4	1	3	8	6
4	9	3	8	7	2	5	6	1
5	2	7	6	1	4	8	9	3
6	8	1	3	9	5	7	2	4



Please contact marketing@niftylift.com with any questions, comments or suggestions.